

PL Electra 10012

Kod produktu: 01-009-004-12-100

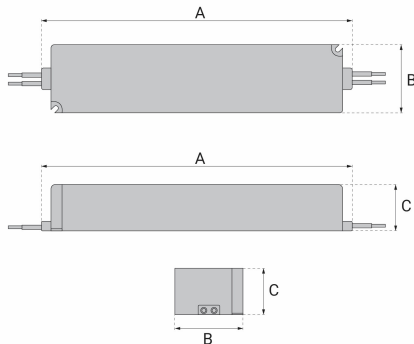

BERGMEN®

Parametry na wejściu

Napięcie:	170~250 V AC
Częstotliwość:	50~60 Hz
Prąd:	0.76 A / 230 V AC
Prąd upływu:	5mA / 230VAC
Zużycie energii w stanie bez obciążenia:	<1W
Sprawność:	84%
Współczynnik mocy (PF):	0.55

Środowisko

Temp. pracy & wilgotność:	-25~50°C; 20~98% RH
Temp. magaz. & wilgotność:	-40~80°C; 10~98% RH
Wibracje:	-

Maks. temperatura obudowy: 80°C

Zabezpieczenia

Przeciwzwarciowe:	TAK
Przeciążeniowe:	TAK
Nadprądowe:	NIE
Temperaturowe:	NIE

Izolacja

Znamionowa wytrzymałość na impuls napięciowy (kV): IN-OUT:AC3KV

Rezystancja izolacji: IN-OUT: DC500V 100MΩ(at room temp. & RH)

Dodatkowe

Klasa szczelności:	67
Wymiary [AxBxC]:	190 x 52 x 37 mm
Przyłącze:	INPUT: 2x20AWG L300mm, OUTPUT: 2x18AWG L300mm
Waga:	0.640 kg
Opakowanie zbiorcze:	20 szt.
Gwarancja w latach:	5

Schemat blokowy

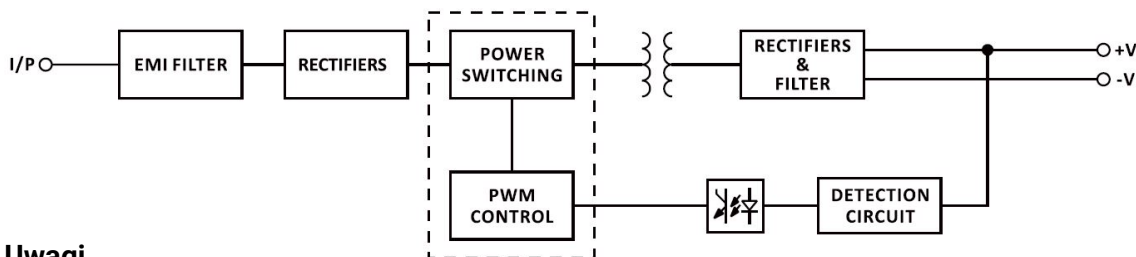

Uwagi

Podane parametry (jeśli nie zaznaczono inaczej) zmierzono dla napięcia zasilania 230V AC przy obciążeniu znamionowym w warunkach laboratoryjnych, przy temperaturze otoczenia 25°C. Zasilacz nie jest niezależnie pracującym urządzeniem, jest zaprojektowany do pracy jako element składowy urządzeń i instalacji. Poziom zakłócenie EM zasilacza może zależeć od charakteru przyłączonego do niego odbiornika, a na zakłócenia sumaryczne całego systemu składają się również zakłócenia generowane przez pozostałe wchodzące w jego skład elementy. Przeznaczenie zasilacza do zasilania produktów oświetleniowych wyposażonych w diody LED może się różnić w zależności od regionu i wymagań lokalnych. Przed zakupem zweryfikuj możliwość użytkowania zasilacza do zasilania produktów LED w oparciu o wymogi prawne w kraju przeznaczenia.

Parametry na wyjściu

Napięcie:	12 V DC
Prąd:	8.33 A
Moc znamionowa:	100 W
Tętnienia napięcia:	100mVp-p
Czas podtrzymania:	-
Dokładność napięcia zależne od obciążenia:	±2%
Dokładność napięcia zależne od parametrów zasilania:	±1%
Dokładność napięcia sumaryczna:	±3%

Derating curve

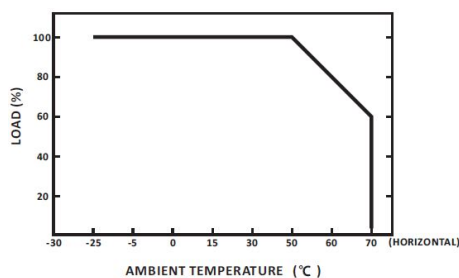

Static characteristics

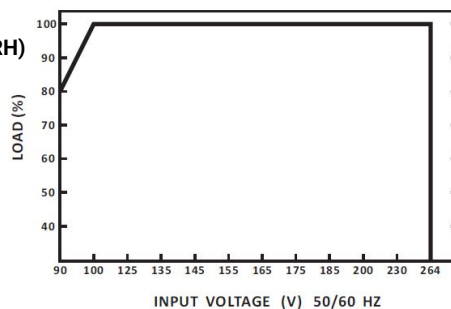

Zasilacze

Components

EN Electra 10012

Product code: 01-009-004-12-100

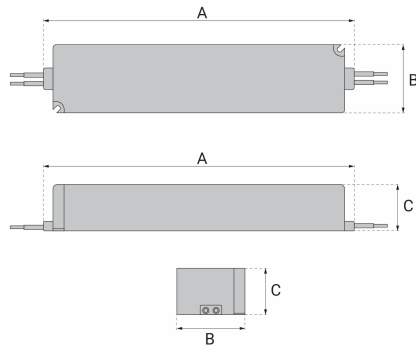

Input Parameters

Voltage:	170~250 V AC
Frequency:	50~60 Hz
Current:	0.76 A / 230 V AC
Leakage current:	5mA / 230VAC
No-load power consumption:	<1W
Efficiency:	84%
Power factor (PF):	0.55

Output Parameters

Voltage:	12 V DC
Current:	8.33 A
Rated power:	100 W
Voltage ripple:	100mVp-p
Hold-up time:	-
Load regulation:	±2%
Line regulation:	±1%
Total voltage accuracy:	± 3%

Environment

Operating temp. & humidity:	-25~50°C; 20~98% RH
Storage temp. & humidity:	-40~80°C; 10~98% RH
Vibration:	-

Max. case temperature: **80°C**

Protection

Short circuit:	YES
Overload:	YES
Overcurrent:	NO
Thermal:	NO

Isolation

Rated withstand impulse voltage (kV):	IN-OUT:AC3KV
Isolation resistance:	IN-OUT: DC500V 100MΩ(at room temp. & RH)

Additional

IP rating:	67
Dimensions [LxWxH]:	190 x 52 x 37 mm
Connection:	INPUT: 2x20AWG L300mm, OUTPUT: 2x18AWG L300mm
Weight:	0.640 kg
Bulk packaging:	20 szt.
Warranty (years):	5

Derating curve

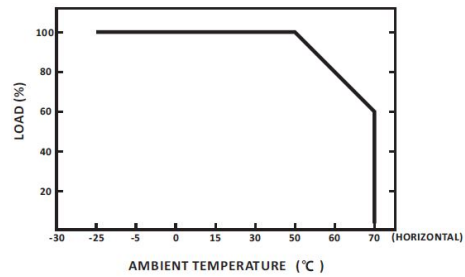

Static characteristics

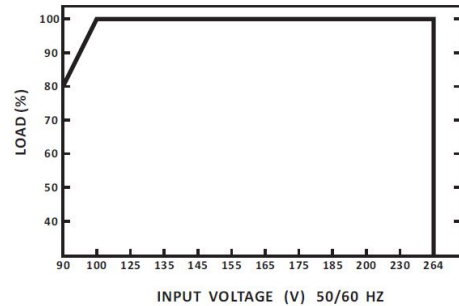

Block Diagram

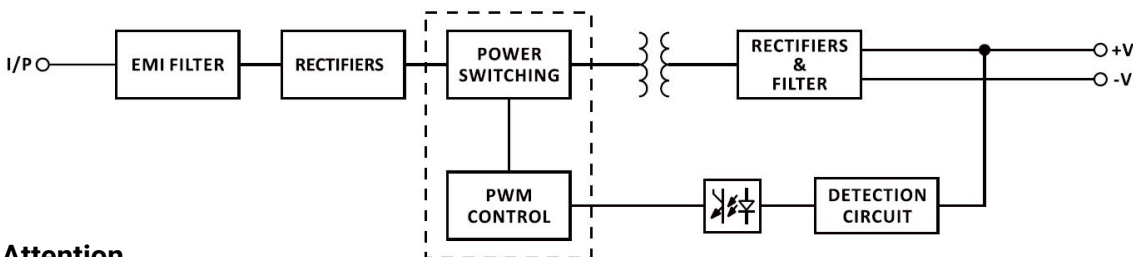

Attention

The specified parameters (unless otherwise noted) were measured at 230V AC supply voltage with rated load under laboratory conditions at an ambient temperature of 25°C. The power supply is not a standalone device, it is designed to operate as a component of equipment and installations. The EM interference level of the power supply may depend on the characteristics of the connected load, and the total interference of the entire system also includes interference generated by other components included in its composition. The intended use of the power supply for powering lighting products equipped with LEDs may vary depending on the region and local requirements. Before purchase, verify the possibility of using the power supply for powering LED products based on legal requirements in the country of destination.

DE Electra 10012

Artikelnummer: 01-009-004-12-100

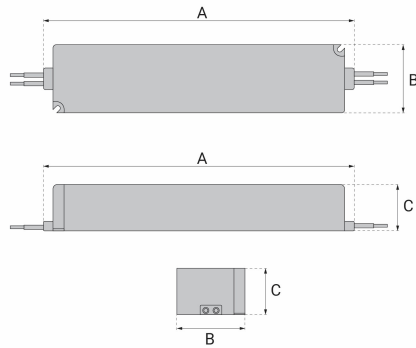

BERGMEN®

Eingangsparameter

Spannung:	170~250 V AC
Frequenz:	50~60 Hz
Strom:	0.76 A / 230 V AC
Einschaltstrom:	5mA / 230VAC
Leerlauf:	<1W
Wirkungsgrad:	84%
Leistungsfaktor (PF):	0.55

Ausgangsparameter

Spannung:	12 V DC
Strom:	8.33 A
Nennleistung:	100 W
Spannungswelligkeit:	100mVp-p
Überbrückungszeit:	-
Lastregelung:	±2%
Netzregelung:	±1%
Gesamtspannungsgenauigkeit:	± 3%

Umgebung

Betriebstemp. & Luftfeuchte:	-25~50°C; 20~98% RH
Lagertemp. & Luftfeuchte:	-40~80°C; 10~98% RH
Vibration:	-

Maximale Gehäusetemperatur: 80°C

Schutzfunktionen

Kurzschlusschutz:	JA
Überlastschutz:	JA
Überstromschutz:	NEIN
Temperaturschutz:	NEIN

Isolierung

Bemessene Stoßspannungsfestigkeit(kV): IN-OUT:AC3KV

Isolationswiderstand: IN-OUT: DC500V 100MΩ(at room temp. & RH)

Zusätzliche Angaben

Dichtheitsklasse:	67
Abmessungen [AxBxC]:	190 x 52 x 37 mm
Anschluss:	INPUT: 2x20AWG L300mm, OUTPUT: 2x18AWG L300mm
Gewicht:	0.640 kg
Sammelverpackung:	20 St.
Garantie in Jahren:	5

Derating curve

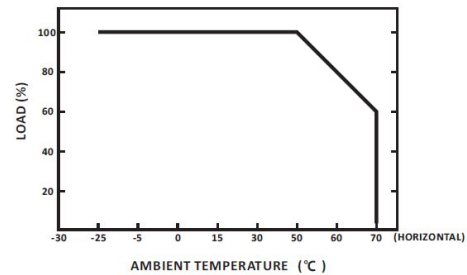

Static characteristics

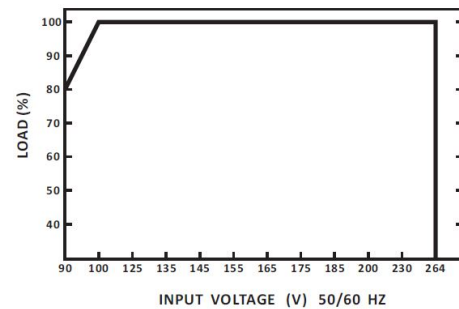

Blockschaltbild

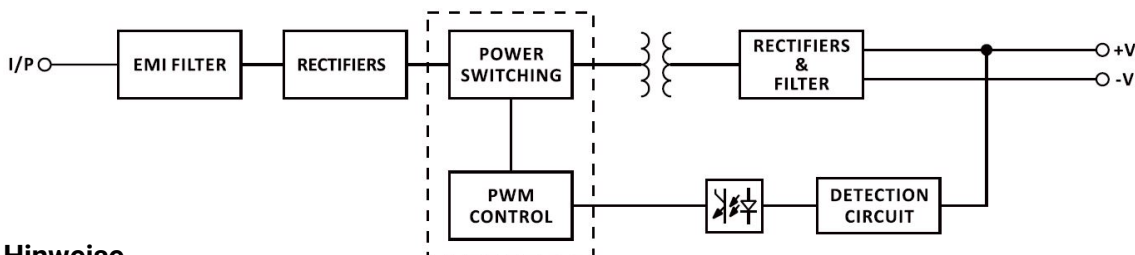

Hinweise

Die angegebenen Parameter (sofern nicht anderbetrieb als Bestandteil von Geräten und Installationen konzipiert). Das Niveau der elektromagnetischen Störungen (EM) des Netzteils kann von der Art des angeschlossenen Verbrauchers abhängen, und die Gesamtstörungen des gesamten Systems setzen sich auch aus den von den übrigen Komponenten erzeugten Störungen zusammen. Die Verwendung des Netzteils zur Versorgung von Beleuchtung Produkten mit LED-Dioden kann je nach Region und lokalen Anforderungen unterschiedlich sein. Vor dem Kauf prüfen Sie bitte die Möglichkeit der Verwendung des Netzteils zur Versorgung von LED-Produkten gemäß den gesetzlichen Anforderungen im Bestimmungsland.



SELV

Bergmen Sp. z o.o., rtm. W. Pileckiego 4 2-050 Skawina, Poland • bergmen.pl

Netzteile

Components

FR Electra 10012

Code produit: 01-009-004-12-100

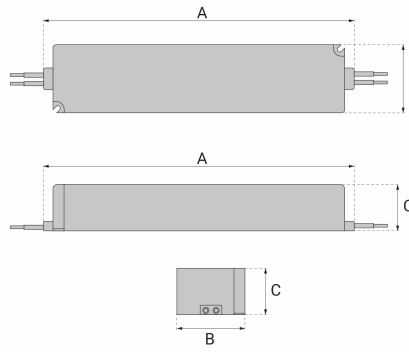

Parametres d'entrée

Tension:	170~250 V AC
Fréquence:	50~60 Hz
Courant:	0.76 A / 230 V AC
Courant de fuite:	5mA / 230VAC
Consommation a vide:	<1W
Rendement:	84%
Facteur de puissance (PF):	0.55

Parametres de sortie

Tension:	12 V DC
Courant:	8.33 A
Puissance nominale:	100 W
Ondulation de tension:	100mVp-p
Temps de maintien:	-
Régulation de charge:	±2%
Régulation de ligne:	±1%
Précision totale de la tension:	± 3%

Environnement

Temp. fonctionnement & humidité: **-25~50°C; 20~98% RH**
 Temp. stockage & humidité: **-40~80°C; 10~98% RH**
 Vibration: **-**

Temp. max. du boîtier: **80°C**

Protection

Court-circuit:	OUI
Surcharge:	OUI
Surintensité:	NON
Thermique:	NON

Isolation

Tenue nominale
 tension d'impulsion (kV): **IN-OUT:AC3KV**

Résistance d'isolation: **IN-OUT: DC500V 100MΩ(at room temp. & RH)**

Supplémentaire

Indice IP:	67
Dimensions [LxIxH]:	190 x 52 x 37 mm
Connexion:	INPUT: 2x20AWG L300mm, OUTPUT: 2x18AWG L300mm
Poids:	0.640 kg
Emballage en vrac:	20 pcs
Garantie (années):	5

Courbe de déclassement

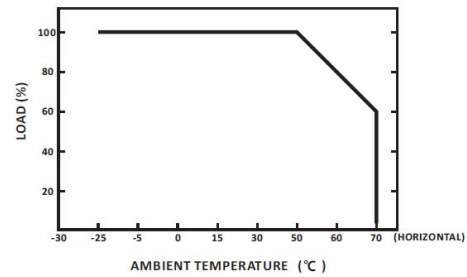

Caractéristiques statiques

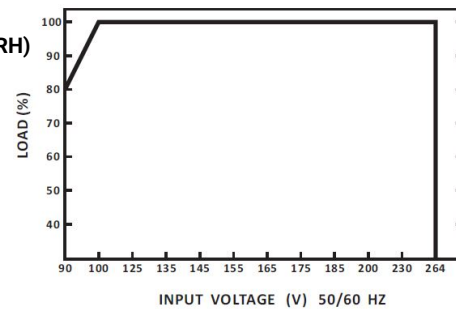

Schéma fonctionnel

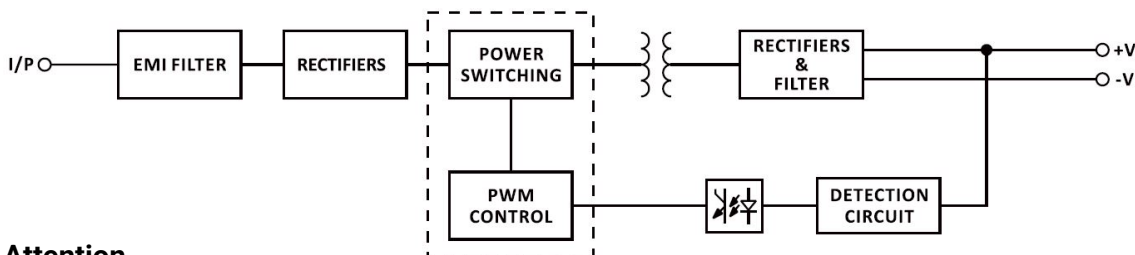

Attention

Les paramètres spécifiés (sauf indication contraire) ont été mesurés à une tension d'alimentation de 230V AC avec une charge nominale dans des conditions de laboratoire à une température ambiante de 25°C. L'alimentation n'est pas un appareil autonome, elle est conçue pour fonctionner comme un composant d'équipements et d'installations. Le niveau d'interférence EM de l'alimentation peut dépendre des caractéristiques de la charge connectée, et l'interférence totale de l'ensemble du système comprend également les interférences générées par d'autres composants inclus dans sa composition. L'utilisation prévue de l'alimentation pour alimenter des produits d'éclairage équipés de LEDs peut varier selon la région et les exigences locales. Avant l'achat, vérifiez la possibilité d'utiliser l'alimentation pour alimenter des produits LED basée sur les exigences légales du pays de destination.